

Article number: 604140012009

Description: Timing belt pulley with hub
HTD 12 3M 9

Measures

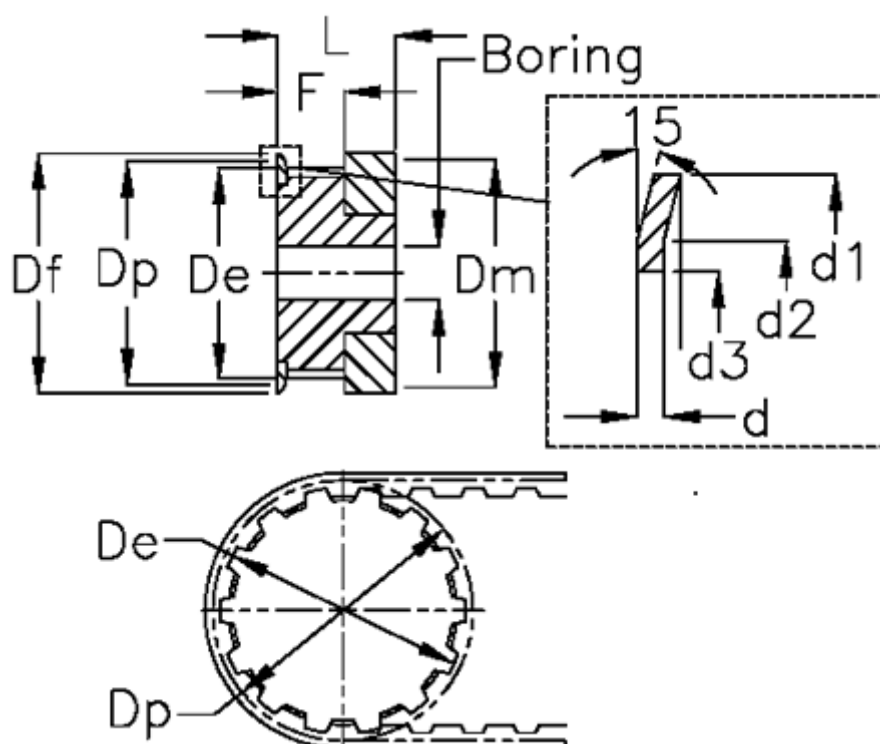

Bore = 4	Dp	= 11.46
d = 0.5	F	= 10.2
d1 = 15	Flange type	= F02
d2 = 12	L	= 17.5
d3 = 8	Tooth number	= 12
De = 10.7	Type	= 3M
Df = 15	Weight	= 0.006
Dm = 15	Width	= 09